

# **KitchenAid®**

---

## **MICROWAVE HOOD COMBINATION**

### **Use & Care Guide**

For questions about features, operation, performance, parts, accessories or service, call: **1-800-422-1230** or visit our website at...  
[www.kitchenaid.com](http://www.kitchenaid.com)

---

Table of Contents..... 2



**Model KHMS145KSS**

4619-652-60621/8183931

---

# TABLE OF CONTENTS

<b>MICROWAVE OVEN SAFETY</b> .....	<b>3</b>
Electrical Requirements .....	5
<b>PARTS AND FEATURES</b> .....	<b>6</b>
Turntable .....	6
Designed Cooking Rack .....	6
<b>MICROWAVE OVEN CONTROL PANEL</b> .....	<b>7</b>
Display .....	7
Number Codes .....	7
Start .....	7
Cancel/Off .....	7
Clock .....	7
Tones .....	8
Timer .....	8
Child Lock .....	8
Vent Fan .....	8
Cooktop Light .....	8
Demo Learning Mode .....	8
<b>BEFORE USING</b> .....	<b>9</b>
Food Characteristics .....	9
Cooking Guidelines .....	9
Cookware and Dinnerware .....	10
Aluminum Foil and Metal .....	10
Cooking Power .....	11
<b>MICROWAVE OVEN USE</b> .....	<b>11</b>
Cooking .....	11
Sensor Cooking .....	12
Auto Cooking .....	12
Easy Minute .....	12
Cooking in Stages .....	13
Reheating .....	13
2-4 Plates .....	13
Custom Defrost .....	14
Easy Simmer .....	14
Keep Warm .....	15
Crisp or Sizzle .....	15
<b>MICROWAVE OVEN CARE</b> .....	<b>16</b>
General Cleaning .....	16
Replacing Filters .....	16
Replacing Cooktop Light .....	17
Replacing Microwave Oven Light .....	17
<b>TROUBLESHOOTING</b> .....	<b>18</b>
<b>ASSISTANCE OR SERVICE</b> .....	<b>19</b>
In the U.S.A. ....	19
<b>WARRANTY</b> .....	<b>20</b>

# MICROWAVE OVEN SAFETY

## Your safety and the safety of others are very important.

We have provided many important safety messages in this manual and on your appliance. Always read and obey all safety messages.



This is the safety alert symbol.

This symbol alerts you to potential hazards that can kill or hurt you and others.

All safety messages will follow the safety alert symbol and either the word "DANGER" or "WARNING." These words mean:

**⚠ DANGER**

**You can be killed or seriously injured if you don't immediately follow instructions.**

**⚠ WARNING**

**You can be killed or seriously injured if you don't follow instructions.**

All safety messages will tell you what the potential hazard is, tell you how to reduce the chance of injury, and tell you what can happen if the instructions are not followed.

## IMPORTANT SAFETY INSTRUCTIONS

When using electrical appliances basic safety precautions should be followed, including the following:

**WARNING:** To reduce the risk of burns, electric shock, fire, injury to persons, or exposure to excessive microwave energy:

- Read all instructions before using the microwave oven.
- Read and follow the specific "PRECAUTIONS TO AVOID POSSIBLE EXPOSURE TO EXCESSIVE MICROWAVE ENERGY" found in this section.
- The microwave oven must be grounded. Connect only to properly grounded outlet. See "GROUNDING INSTRUCTIONS" found in this section and in the provided Installation Instructions.
- Install or locate the microwave oven only in accordance with the provided Installation Instructions.
- Some products such as whole eggs in the shell and sealed containers – for example, closed glass jars – may explode and should not be heated in the microwave oven.
- Use the microwave oven only for its intended use as described in this manual. Do not use corrosive chemicals or vapors in the microwave oven. This type of oven is specifically designed to heat, cook, or dry food. It is not designed for industrial or laboratory use.
- As with any appliance, close supervision is necessary when used by children.
- Do not operate the microwave oven if it has a damaged cord or plug, if it is not working properly, or if it has been damaged or dropped.
- The microwave oven should be serviced only by qualified service personnel. Call an authorized service company for examination, repair, or adjustment.
- See door surface cleaning instructions in the "Microwave Oven Care" section.
- To reduce the risk of fire in the oven cavity:
  - Do not overcook food. Carefully attend the microwave oven if paper, plastic, or other combustible materials are placed inside the oven to facilitate cooking.
  - Remove wire twist-ties from paper or plastic bags before placing bags in oven.
  - If materials inside the oven should ignite, keep oven door closed, turn oven off, and disconnect the power cord, or shut off power at the fuse or circuit breaker panel.
  - Do not use the cavity for storage purposes. Do not leave paper products, cooking utensils, or food in the cavity when not in use.

**SAVE THESE INSTRUCTIONS**

## IMPORTANT SAFETY INSTRUCTIONS

- Suitable for use above both gas and electric cooking equipment.
- Intended to be used above ranges with maximum width of 36 inches.
- Clean Ventilating Hoods Frequently - Grease should not be allowed to accumulate on hood or filter.
- Oversized foods or oversized metal utensils should not be inserted in the microwave oven as they may create a fire or risk of electric shock.
- Do not clean with metal scouring pads. Pieces can burn off the pad and touch electrical parts involving a risk of electric shock.
- Do not use paper products when appliance is operated in the "PAN BROWN" mode.
- Do not store any materials, other than manufacturer's recommended accessories, in this oven when not in use.
- Do not store anything directly on top of the microwave oven when the microwave oven is in operation.
- When flaming foods under the hood, turn the fan on.
- Use care when cleaning the vent-hood filter. Corrosive cleaning agents, such as lye-based oven cleaners, may damage the filter.
- Do not cover or block any openings on the microwave oven.
- Do not store this microwave oven outdoors. Do not use the microwave oven near water - for example, near a kitchen sink, in a wet basement, or near a swimming pool, and the like.
- Do not immerse cord or plug in water.
- Keep cord away from heated surfaces.
- Do not let cord hang over edge of table or counter.
- Do not mount over a sink.
- Do not cover racks or any other part of the oven with metal foil. This will cause overheating of the oven.

## SAVE THESE INSTRUCTIONS

## PRECAUTIONS TO AVOID POSSIBLE EXPOSURE TO EXCESSIVE MICROWAVE ENERGY...

- (a) Do not attempt to operate this oven with the door open since open-door operation can result in harmful exposure to microwave energy. It is important not to defeat or tamper with the safety interlocks.
- (b) Do not place any object between the oven front face and the door or allow soil or cleaner residue to accumulate on sealing surfaces.
- (c) Do not operate the oven if it is damaged. It is particularly important that the oven door close properly and that there is no damage to the:
  - (1) Door (bent),
  - (2) Hinges and latches (broken or loosened),
  - (3) Door seals and sealing surfaces.
- (d) The oven should not be adjusted or repaired by anyone except properly qualified service personnel.

## Electrical Requirements

### **⚠ WARNING**



#### **Electrical Shock Hazard**

**Plug into a grounded 3 prong outlet.**

**Do not remove ground prong.**

**Do not use an adapter.**

**Do not use an extension cord.**

**Failure to follow these instructions can result in death, fire, or electrical shock.**

Observe all governing codes and ordinances. A 120 Volt, 60 Hz, AC only, 15- or 20-amp fused electrical supply is required. (A time-delay fuse or circuit breaker is recommended.) It is recommended that a separate circuit serving only this appliance be provided.

## **GROUNDING INSTRUCTIONS**

### ■ **For all cord connected appliances:**

The microwave oven must be grounded. In the event of an electrical short circuit, grounding reduces the risk of electric shock by providing an escape wire for the electric current. The microwave oven is equipped with a cord having a grounding wire with a grounding plug. The plug must be plugged into an outlet that is properly installed and grounded.

**WARNING:** Improper use of the grounding plug can result in a risk of electric shock. Consult a qualified electrician or serviceman if the grounding instructions are not completely understood, or if doubt exists as to whether the microwave oven is properly grounded.

Do not use an extension cord. If the power supply cord is too short, have a qualified electrician or serviceman install an outlet near the microwave oven.

### ■ **For a permanently connected appliance:**

This appliance must be connected to a grounded, metallic, permanent wiring system, or an equipment grounding conductor should be run with the circuit conductors and connected to the equipment grounding terminal or lead on the appliance.

**SAVE THESE INSTRUCTIONS**

# PARTS AND FEATURES

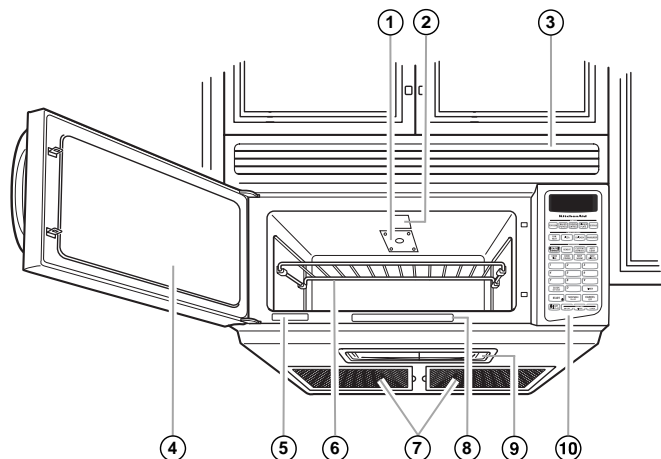

- |   |                                     |
|---|-------------------------------------|
| 1. Microwave Inlet Cover                                | 8. Cooking Guide Label              |
| 2. Microwave Light                                      | 9. Cooktop Light                    |
| 3. Vent Grille  | 10. Control Panel                   |
| 4. Metal Shielded Window                                |                                     |
| 5. Model and Serial Number Plate                        | <b>Parts and Features not shown</b> |
| 6. Cooking Rack   | Turntable                           |
| 7. Charcoal and Grease Filters (shipped in oven cavity) | Crisper Pan                         |

## Turntable

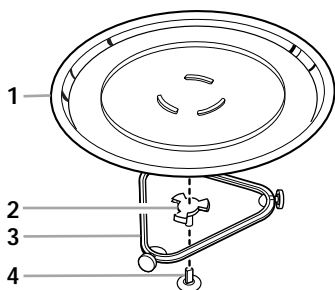

1. Turntable
2. Hub
3. Support
4. Shaft

The turntable rotates in both directions to help cook food more evenly. Do not operate the microwave oven without the turntable in place. See "Assistance or Service" to reorder any of the parts.

### To Install:

1. Remove tape from the hub.
2. Place the support on the oven cavity bottom.
3. Place the turntable on the support.  
Fit the raised, curved lines in the center of the turntable bottom between the three spokes of the hub. The rollers on the support should fit inside the turntable bottom ridge.

### To Turn Off:

The turntable can be turned off (except during an auto function). This is helpful when cooking with plates that are larger than the turntable or when cooking with two 10 in. (25 cm) plates that are side-by-side.

1. Touch TURNTABLE ON/OFF.  
"TURNTABLE OFF" will appear in the display. Display will prompt you to enter cook time.
2. Touch number pads to enter length of time to cook.
3. Touch START/ENTER (or START).  
For optimal results, halfway through cook time turn plate(s) so the food in the front is in the back.
4. Touch OFF/CANCEL (or CANCEL/OFF) or open the door to clear the display and/or stop reminder tones.  
Turntable will be turned back on.

## Designed Cooking Rack

The cooking rack is ideal for two-level cooking. It provides extra cavity space for cooking two or more containers at the same time. Insert the rack securely into the rack supports on the side walls of the oven. See "Assistance or Service" section to reorder rack.

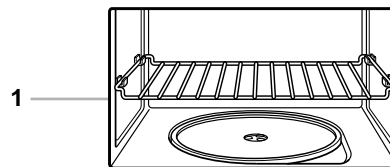

### 1. Proper Use

- Rack will become hot. Always use oven mitts or pot holders when handling.
- Do not allow the rack to touch the inside cavity walls, ceiling or floor.
- Do not use metal cookware, utensils, or a browning dish with the rack.
- Do not let food container on rack touch the top or sides of the oven.
- Do not place popcorn bags on rack.
- The rack is designed specifically for this oven. Do not use it in any other oven.
- Do not cook food directly on the rack. Always use a microwave-safe container.
- Only use the rack when cooking on two levels. Do not store it in the oven. Damage to the oven could result if someone accidentally turns on the oven.

# MICROWAVE OVEN CONTROL PANEL

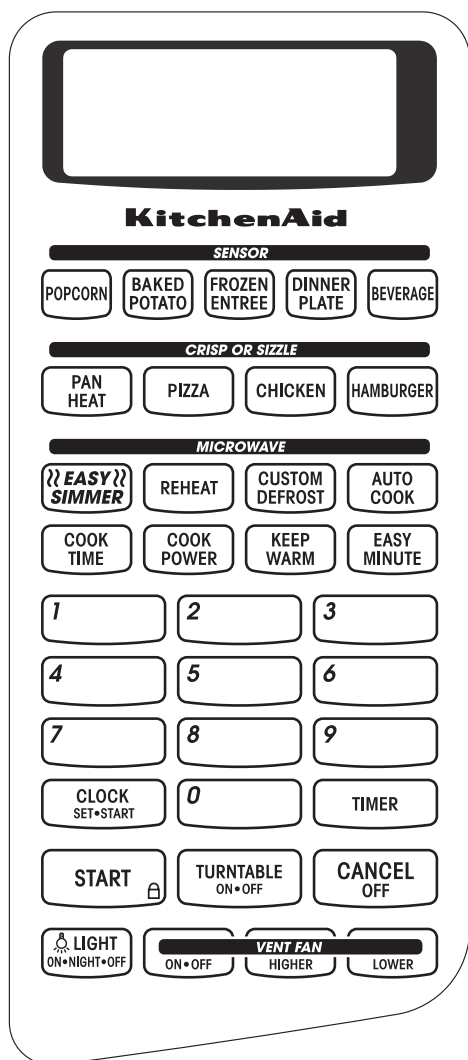

## Display

When power is first supplied to the microwave oven, a “:” will blink on the display. Touch CANCEL/OFF to stop the blinking.

Any other time a “:” blinks on the display, a power failure has occurred. Touch CANCEL/OFF and reset the clock if needed.

When the microwave oven is in use, the display shows cooking power, quantities, weights and/or prompts.

If “RETRY” blinks on the display for one second, an invalid pad was touched. Retry your entry.

When the microwave oven is not in use, the display shows the time of day or Timer countdown.

## Number Codes

The microwave oven is preset with shortcut number codes. A number code includes one or more of the following: cooking power, cook time and food quantity or weight. See the code charts in the “Cooking” and “Reheating” sections for additional information.

## Start

The START pad begins any function. If not touched within 5 seconds of touching a pad, the START? indicator light will glow. If not touched within one minute of touching a pad, the display returns to the time of day.

If cooking is interrupted during a non-sensor function, the START? indicator light will glow. Touching START will resume the cycle.

If cooking is interrupted during a sensor function, the function is cancelled, and cannot be resumed by touching START.

## Cancel/Off

The CANCEL/OFF pad clears any incorrect command and cancels any program during cooking. It will not erase the time of day.

The microwave oven will also turn off when the door is opened. Close the door and touch START to resume the non-sensor cycle.

## Clock

This is a 12 hour clock and does not show a.m. or p.m.

### To Set:

Before setting, make sure the microwave oven and Timer are off.

1. Touch CLOCK SET/START.
2. Touch the number pads to set the time of day.
3. Touch CLOCK SET/START or START.

### To Remove:

1. Touch CLOCK SET/START.
2. Touch 0.
3. Touch CLOCK SET/START.

The time will disappear and “:” will appear on the display.

---

## Tones

Tones are audible signals, indicating the following:

### One tone

- Valid pad touch (short tone)
- End of Timer countdown (long tone)

### Two tones

- Reminder, repeat each minute after the end-of-cycle tones
- Function has been entered or exited

### Three tones

- Invalid pad touch

### Four tones

- End-of-cycle

### All Tones

All of the preceding tones are preset on. All except the end of Timer countdown can be turned off.

**To Turn Off/On:** Touch and hold the number pad [2] for five seconds until two tones sound. Repeat to turn tones back on.

### Valid Pad Touch Tones

The valid pad touch tones are preset on, but can be turned off.

**To Turn Off/On:** Touch and hold the number pad [1] for five seconds or until two tones sound. Repeat to turn tones back on.

---

## Timer

The Timer can be set in minutes and seconds, up to 99 minutes 99 seconds and counts down the set time. The Timer does not start or stop the microwave oven.

When the Timer is in use, the microwave oven can still operate. To see the time countdown for five seconds while the microwave oven is in use, touch **TIMER**.

### To Set:

1. Touch **TIMER**.  
If no action is taken after one minute, the display will return to the time of day mode.
2. Touch the number pads to set the length of time.
3. Touch **START**.  
If not touched within 5 seconds, "START?" will appear on the display. If not touched within 1 minute, the display will return to the time of day.  
When the set time ends, "END" will appear on the display and 1 long tone will sound.
4. Touch **TIMER** or **CANCEL/OFF** anytime to cancel the Timer.  
If using the Timer during a cooking function, do not touch **CANCEL/OFF** to cancel Timer, as the cooking function will also cancel.

The time can be reset during the countdown by repeating the above steps.

---

## Child Lock

The Child Lock shuts down the control panel pads to prevent unintended use of the microwave oven.

When the control is locked, only the **VENT FAN**, **LIGHT**, and **START** pads, and number pads 1 and 2 will function. If any other pad is touched, 3 tones will sound and "LOCK" will appear in the display.

The Control Lock is preset unlocked, but can be locked.

**To Lock/Unlock Control:** Before locking, make sure the microwave oven and Timer are off. Touch and hold **START** for five seconds until two tones sound and a lock icon appears on the display. Repeat to unlock and remove the lock picture from display.

---

## Vent Fan

The vent fan has speeds ranging from 1 (LOW) to 5 (HIGH). The first time the Vent Fan is turned on after power is supplied to the microwave oven, it will start at speed level 1. Each time the fan is turned on, it will start at the speed level that was used last.

To protect the microwave oven, the vent fan will automatically turn on at the HIGH setting if the temperature from the range or cooktop below gets too hot. It may stay on for up to one hour to cool the microwave oven. When this occurs, the **VENT FAN** pads will not function.

### To Turn Vent Fan On/Off:

1. Touch **VENT FAN ON/OFF** pad.
2. Touch **HIGHER** or **LOWER** pad to increase or decrease the fan speed.

The display will show "FAN" and a number between 1 and 5 to indicate fan speed. After 2 seconds, the display returns to previous display.

---

## Cooktop Light

The cooktop light has three options: on, night and off.

**To Turn On/Night/Off:** Repeatedly touch **LIGHT ON/NIGHT/OFF** to cycle through options.

---

## Demo Learning Mode

The demo learning mode is ideal for learning how to use the microwave oven. When set, functions can be entered without actually turning on the magnetron. The microwave oven light will come on, the fan will run and, if on, the turntable will rotate.

Before setting, make sure the microwave oven and Timer are off.

**To Turn On/Off:** Touch and hold **TIMER** for five seconds until two tones sound and "d" appears on the display. Repeat to turn off and remove "d" from the display.



---

# BEFORE USING

A magnetron in the oven produces microwaves which reflect off the metal floor, walls and ceiling and pass through the turntable and appropriate cookware to the food. Microwaves are attracted to and absorbed by fat, sugar and water molecules in the food, causing them to move, producing friction and heat which cooks the food.

- Never lean on or allow children to swing on the oven door.
- Do not operate microwave oven when it is empty.
- Heated liquids can splash out during and after heating. Use of a wooden stir stick placed in the cup or bowl during heating may help to avoid this.
- The turntable must be in place and correct side up when oven is in use. Do not use if turntable is chipped or broken. See "Assistance or Service" section to reorder.
- Baby bottles and baby food jars should not be heated in the oven.
- Clothes, flowers, fruit, herbs, wood, gourds, paper, including brown paper bags and newspaper should not be dried in the oven.
- Do not use the microwave oven for canning, sterilizing or deep frying. The oven cannot maintain appropriate temperatures.
- Paraffin wax will not melt in the oven because it does not absorb microwaves.
- Use oven mitts or pot holders when removing containers from oven.
- Do not overcook potatoes. At the end of the recommended cook time, potatoes should be slightly firm. Let potatoes stand for five minutes. They will finish cooking while standing.

---

## Food Characteristics

When microwave cooking, the amount, size and shape, starting temperature, composition and density of the food affect cooking results.

### Amount of Food

The more food heated at once the longer the cook time. Check for doneness and add small increments of time if necessary.

### Size and Shape

Smaller pieces of food will cook more quickly than larger pieces and uniformly shaped foods cook more evenly than irregularly shaped food.

### Starting Temperature

Room temperature foods will heat faster than refrigerated foods and refrigerated foods will heat faster than frozen foods.

### Composition and Density

Foods high in fat and sugar will reach a higher temperature and heat faster than other foods. Heavy, dense foods, such as meat and potatoes, require a longer cook time than the same size of a light, porous food, such as cake.

---

## Cooking Guidelines

### Covering

Covering food helps retain moisture, shorten cook time and reduce spattering. Use the lid supplied with cookware. If lid is not available, wax paper, paper towels or plastic wrap approved for microwaves may be used. Plastic wrap should be turned back at one corner to provide an opening to vent steam.

### Stirring and Turning

Stirring and turning redistributes heat evenly to avoid overcooking the outer edges of food. Stir from outside to center. If possible, turn food over from bottom to top.

### Arranging

If heating irregularly shaped or different sized foods, the thinner parts and smaller sizes should be arranged toward the center. If cooking several items of the same size and shape, place them in a ring pattern, leaving the center of the ring empty.

### Piercing

Before heating, use a fork or small knife to pierce or prick foods that have a skin or membrane, such as potatoes, egg yolks, chicken livers, hot dogs, and sausage. Prick in several places to allow steam to vent.

### Shielding

Use small, flat pieces of aluminum foil to shield the thin pieces of irregularly shaped foods, bones and foods such as chicken wings, leg tips and fish tail. See "Aluminum Foil and Metal" first.

### Standing Time

Food will continue to cook by the natural conduction of heat even after the microwave cycle ends. The length of standing time depends on the volume and density of the food.

---

## Cookware and Dinnerware

Cookware and dinnerware must fit on the turntable. Always use oven mitts or pot holders when handling because any dish may become hot from heat transferred from the food. Do not use cookware and dinnerware with gold or silver trim. Use the following chart as a guide, then test before using.

MATERIAL	RECOMMENDATIONS
Aluminum Foil, Metal	See "Aluminum Foil and Metal" section.
Browning Dish	Bottom must be at least $\frac{3}{16}$ in. (5 mm) above the turntable. Follow manufacturer's recommendations.
Ceramic Glass, Glass	Acceptable for use.
China, Earthenware	Follow manufacturer's recommendations.
Melamine	Follow manufacturer's recommendations.
Paper Towels, Dinnerware, Napkins	Use non-recycled and those approved by the manufacturer for microwave oven use.
Plastic Wraps, Bags, Covers, Dinnerware, Containers	Use those approved by the manufacturer for microwave oven use.
Pottery and Clay	Follow manufacturer's recommendations.
Styrofoam	Do not use in oven.
Straw, Wicker, Wooden Containers	Do not use in oven.
Wax Paper	Acceptable for use.

### To Test Cookware or Dinnerware for Microwave Use:

1. Put cookware or dinnerware in oven with 1 cup (250 mL) of water beside it.
2. Cook at 100% cooking power for 1 minute.

Do not use cookware or dinnerware if it becomes hot and the water stays cool.

---

## Aluminum Foil and Metal

Always use oven mitts or pot holders when removing dishes from the microwave oven.

Aluminum foil and some metal can be used in the oven. If not used properly, arcing (a blue flash of light) can occur and cause damage to the oven.

---

### OK for Use

Racks and bakeware supplied with the oven, aluminum foil for shielding, and approved meat thermometers may be used with the following guidelines:

- Never allow aluminum foil or metal to touch the inside cavity walls, ceiling or floor.
- Always use the turntable.
- Never allow contact with another metal object during cooking.

---

### Do Not Use

Metal cookware and bakeware, gold, silver, pewter, non-approved meat thermometers, skewers, twist ties, foil liners such as sandwich wrappers, staples and objects with gold or silver trim or a metallic glaze should not be used in the oven.

---

## Cooking Power

Many recipes for microwave cooking specify which cooking power to use by percent, name or number. For example, 70%=7=Medium-High.

Use the following chart as a general guide for the suggested cooking power of specific foods.

PERCENT/ NAME	NUMBER	USE
100%, High (default setting)	10	Quick heating convenience foods and foods with high water content, such as soups, beverages and most vegetables.
90%	9	Cooking small tender pieces of meat, ground meat, poultry pieces and fish fillets. Heating cream soups.
80%	8	Heating rice, pasta or casseroles. Cooking and heating foods that need a cook power lower than high. For example, whole fish and meat loaf.
70%, Medium-High	7	Reheating a single serving of food.
60%	6	Cooking sensitive foods such as cheese and egg dishes, pudding and custards. Cooking non-stirrable casseroles, such as lasagna.
50%, Medium	5	Cooking ham, whole poultry and pot roasts. Simmering stews.
40%	4	Melting chocolate. Heating bread, rolls and pastries.
30%, Medium-Low, Defrost	3	Defrosting bread, fish, meats, poultry and precooked foods.
20%	2	Softening butter, cheese, and ice cream.
10%, Low	1	Taking chill out of fruit.

### To Set a Cooking Power other than 100%:

1. Touch COOK TIME.
2. Touch the number pads to set a length of time to cook.
3. Touch COOK POWER.
4. Touch the number pad using the Cooking Power chart.
5. Touch START.  
The display will count down the cook time.  
When the cycle ends, "END" will appear in the display, 4 end-of-cycle tones will sound, and then reminder tones will sound every minute.
6. Touch CANCEL/OFF or open the door to clear the display and/or stop reminder tones.

---

# MICROWAVE OVEN USE

---

## Cooking

### To Use:

1. Touch COOK TIME.
2. Touch the number pads to set a length of time to cook.  
Touch COOK POWER to set a cooking power other than 100%. Touch the number pad(s) using the Cooking Power chart.
3. Touch START.  
The display will count down the cook time.  
When the cycle ends, "END" will appear in the display, 4 end-of-cycle tones will sound, and then reminder tones will sound every minute.
4. Touch OFF/CANCEL (or CANCEL/OFF) or open the door to clear the display and/or stop reminder tones.  
The cook time and cooking power can be changed at any time after touching START by repeating the above steps.

## Sensor Cooking

A sensor in the microwave oven detects humidity released from the food and automatically sets a cooking time based on the selected pad.

Use the following chart as a guide for the five food pads.

FOOD	SERVING SIZE	INSTRUCTIONS
Baked Potato	1 to 4 medium, 10 to 13 oz (264 to 369 g) each	Pierce each one several times with a fork. Place on turntable around edges, at least 1 in. (2.5 cm) apart. At the end of cooking, let stand 5 minutes.
Frozen Entree	10 to 20 oz (284 to 567 g)	Remove from package. Loosen cover on three sides. If not in microwavable container, place on plate, cover with plastic wrap and vent.
Beverage (room temperature)	1 or 2 8-ounce (250 mL) cups	Do not cover. The diameter of the cup's opening will affect how it heats. A smaller diameter opening may become hotter.
Dinner Plate (refrigerated)	1 serving (1 plate), 8 to 16 oz (.2 to .45 kg)	Place food on plate, cover with plastic wrap and vent.
*Popcorn	3.5 oz (100 g) 3 oz (85 g) 1.75 oz (50 g)	Pop only one package at a time.

\*Do not use regular paper bags or glass utensils. Listen for popping to slow to 1 pop every 1 or 2 seconds. Do not try to pop unpopped kernels. Use fresh bags of popcorn for optimal results. Cooking results may vary by brand and fat content. If using a microwave popcorn popper, follow manufacturer's instructions.

### To Use Sensor Cooking:

Before using, make sure the microwave oven has been plugged in for at least 2½ minutes, the room temperature is not above 95°F (35°C) and the outside of the container and microwave oven cavity are dry.

1. Touch one of the five SENSOR food pads.

The microwave oven will automatically turn on. While the cooking time is being estimated, "SENSE" will appear in the display. Then the SENSOR set time counts down on the display, and "MAX" appears every 3 seconds.

When the cycle ends, "END" will appear in the display, 4 end-of-cycle tones will sound, and then reminder tones will sound every minute.

2. Touch CANCEL/OFF or open the door to clear the display and/or stop reminder tones.

The cook time (except POPCORN) can be changed for twenty seconds after touching a pad.

**To Change Cook Time:** Touch COOK POWER repeatedly to scroll through "MORE," "LESS" or "NORML" time.

## Auto Cooking

Times and cooking power have been preset for 5 microwavable foods. Use the following chart as a guide.

FOOD	CODE	QUANTITY
*Rice (sensor)	1	.5 to 2 cups (125 mL to 500 mL)
**Bacon	2	1 to 6 pieces, average thickness
Instant Cereal	3	1 to 4 servings
French Toast, frozen	4	1 to 4 pieces
Canned Vegetables	5	1 to 4 cups (250 mL to 1 L)

\*Make sure the microwave oven has been plugged in for at least 2½ minutes. No quantity needs to be entered. The amount listed is the amount to cook.

\*\*Differences in the amount of fat, meat, thickness, and curing process affect results. Average is 16 slices per pound.

### To Use Auto Cook:

1. Touch AUTO COOK.  
The display shows "PAD".
2. Touch AUTO COOK repeatedly to scroll through foods.  
or  
Touch a number pad to select type of food from chart.
3. Touch number pads to enter quantity, except for Rice.
4. Touch START.  
The display will count down the cook time.  
When the cycle ends, "End" will appear in the display, 4 end-of-cycle tones will sound, and then reminder tones will sound every minute.
5. Touch CANCEL/OFF or open the door to clear the display and/or stop reminder tones.

**To Change Cook Time:** Touch COOK POWER repeatedly to scroll through "MORE," "LESS" or "NORML" time.

## Easy Minute

The Easy Minute function allows the addition of cook time in one-minute increments. If the EASY MINUTE pad is touched during cooking, one minute of cook time at the current cook power setting and/or in the current cooking stage will be added. If the pad is touched after cooking is over, one minute of cook time at 100% cook power will be added. Up to 99 minutes of cook time may be added by touching EASY MINUTE.

Cook power can be changed after touching EASY MINUTE by touching COOK POWER, touching number pads to enter the cook power, and then touching START.

## Cooking in Stages

The oven can be set to cook at different cooking powers for various lengths of time, up to three stages. Cook settings can be used in any order, except defrosting, which must be the first stage.

Sensor cooking cannot be done in stages.

### To Cook in Stages:

1. Touch COOK TIME.
2. Touch number pads to enter length of time to cook during the first stage.
3. Touch COOK POWER.
4. Touch the number pad(s) using the Cooking Power chart to set the cooking power for the first cycle.
5. Repeat steps 1-4 for the second and third cycles.
6. Touch START.

The display will countdown each of the cook times. A "1," "2" or "3" will appear on the display during their respective stages.

When the cycle ends, "End" will appear in the display, 4 end-of-cycle tones will sound, and then reminder tones will sound every minute.

7. Touch CANCEL/OFF or open the door to clear the display and/or stop reminder tones.

The cook time and cooking power of the cycling stage can be changed after touching START without interrupting cooking.

**To Change Cook Time:** Touch COOK TIME. Use the number pads to enter the new cook time. Touch START.

**To Change Cooking Power:** Touch COOK POWER. Use the number pads to enter the new cooking power or repeatedly touch COOK POWER. Touch START.

4. Touch START.

The display will count down the reheat time.

When the cycle ends, "End" will appear in the display. If on, end-of-cycle tones will sound, then reminder tones will sound every minute.

5. Touch CANCEL/OFF or open the door to clear the display and/or stop reminder tones.

**To Change Cook Time:** Touch COOK POWER repeatedly to scroll through "MORE", "LESS" or "NORML" time.

## 2-4 Plates

Two 10¼ inch (26 cm) plates may be heated side-by-side, or one dish larger than the turntable, plus 2 plates on the cooking rack. For best results, halfway through heating, turn the plates (or larger dish) halfway around, and switch plates between top and bottom (if heating more than 2 plates).

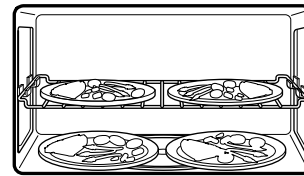

The turntable should be turned off while heating 2 bottom plates or one larger dish. See "Turntable" section.

## Reheating

Times and cooking power have been preset for reheating five specific foods. Use the following chart as a guide.

FOOD	CODE	QUANTITY
*Pizza Slice (refrigerated-sensor)	1	1 to 3 slices, 5 oz (142 g) each
*Sauce (sensor)	2	1 to 4 cups (250 mL to 1 L)
Casserole (refrigerated)	3	1 to 4 cups (250 mL to 1 L)
Baked Goods (example: medium muffin or bagel)	4	1 to 6 pieces, 2 oz (57 g) each
*Soup	5	1 to 4 cups (250 mL to 1 L)

\*Make sure the microwave oven has been plugged in for at least 2½ minutes.

### To Use Reheat:

1. Touch REHEAT.
2. Touch number pad from chart  
or  
Touch REHEAT repeatedly to scroll through foods.
3. Touch number pads to enter quantity.

---

## Custom Defrost

The Custom Defrost feature can be used, or the microwave oven can be manually set to defrost by using 30% cook power.

- Food should be 0°F (-18°C) or colder at defrosting for optimal results.
- Unwrap foods and remove lids (from fruit juice) before defrosting.
- Shallow packages will defrost more quickly than deep blocks.
- Separate food pieces as soon as possible during or at the end-of-cycle for more even defrosting.
- Use small pieces of aluminum foil to shield parts of food such as chicken wings, leg tips and fish tails. See "Aluminum Foil and Metal" first.

The Custom Defrost system has three categories: Meat, Poultry and Fish. It should not be used for food left outside the freezer more than 20 minutes and frozen ready-made food. Use the following chart as a guide.

---

### MEAT

---

*Beef:* ground, steaks, roast, stew

The narrow or fatty areas of irregular shaped cuts should be shielded with foil before defrosting.

*Lamb:* stew and chops

Do not defrost less than ¼ lb (113 g) or two 4 oz (113 g) patties.

*Pork:* chops, ribs, roasts, sausage

Place all meats, except stew cubes and bulk sausage, on microwavable roasting rack provided with the microwave oven.

Place stew cubes and bulk sausage in microwavable baking dish.

---

### POULTRY

---

*Chicken:* whole and cut up

Place on microwavable roasting rack, chicken breast-side up.

*Cornish hens*

Remove giblets from whole chicken.

*Turkey:* breast

---

### FISH

---

*Fillets, Steaks, Whole, Shellfish*

Place in microwavable baking dish.

---

#### To use Custom Defrost:

1. Touch CUSTOM DEFROST.
2. Touch the number pad 1 for Meat, 2 for Poultry or 3 for Fish or  
Touch CUSTOM DEFROST control repeatedly to scroll through foods.
3. Touch the number pads to enter the weight.  
Meats and Poultry can be set from .1 to 6.6 lb (45 g to 3 kg).  
Fish can be set from .1 to 4.4 lb (45 g to 2 kg).

4. Touch START.

The display will count down the defrost time.

When the cycle ends, "End" will appear in the display, 4 end-of-cycle tones will sound, and then reminder tones will sound every minute.

5. Touch CANCEL/OFF or open the door to clear the display.

The cook time can be changed during the defrosting cycle without interrupting cooking.

**To Change Defrost Time:** Touch COOK POWER repeatedly to scroll through "MORE", "LESS", or "NORML" time.

---

## Easy Simmer

Use Easy Simmer for foods like soups, casseroles, stews and other liquid food. It can also be used to cook pasta. Cook power or doneness cannot be changed during this function, as it uses the sensor.

#### To Use Easy Simmer:

Before using, make sure the microwave oven has been plugged in for at least 2½ minutes, add ¼ to ½ cup (60 to 125 mL) of water to vegetables and cover dish with its lid, not plastic wrap.

1. Touch EASY SIMMER.
2. Touch the number pads to set a length of time to simmer.
3. Touch START.

"BOIL" will appear on the display. When water begins to boil the display will count down the simmer time.

When the cycle ends, "End" will appear in the display, 4 end-of-cycle tones will sound, and then reminder tones will sound every minute.

4. Touch OFF/CANCEL (or CANCEL/OFF) or open the door to clear the display and/or stop reminder tones.

Simmer time may be changed after Easy Simmer program starts by repeating steps 2 and 3.

#### Simmering Pasta

Use a container large enough to cover food completely with water. Add 1 tablespoon (15 mL) oil to water. Put container and water in the microwave oven and follow the above steps, setting a simmer time of one second. When time ends place food in the water. Cover, then follow the above steps setting the desired simmer time.

## Keep Warm

### **! WARNING**

#### **Food Poisoning Hazard**

**Do not let food sit in oven more than one hour before or after cooking.**

**Doing so can result in food poisoning or sickness.**

Hot cooked food can be kept warm in the microwave oven. Warm Hold can be used by itself or after an automatic cooking cycle. Opening the door before the cycle ends will cancel the function.

#### **To Use:**

Put hot cooked food in the oven. Cover plates of food and foods that were cooked covered. Pastries, pies, turnovers, etc. should remain uncovered.

1. Touch KEEP WARM.
2. Touch START.  
"WARM" will appear on the display and the warm time will countdown.  
When the cycle ends, "End" will appear in the display, 4 end-of-cycle tones will sound, and then reminder tones will sound every minute.
3. Touch CANCEL/OFF or open the door to clear the display and/or stop reminder tones.

**To Set at end of cycle: Touch KEEP WARM while setting a cooking cycle before touching START, or during cooking. When the last cooking cycle is over, 2 tones will sound, and then "WARM" will appear in the display.**

## Crisp or Sizzle

The Pan Heat feature, combined with Crisp or Sizzle features, uses the Crisper Pan to brown, crisp, and pan-fry foods in the microwave oven. Pan Heat preheats the pan to 410°F in approximately 3 minutes.

While microwaves heat food from above, they also heat the pan very quickly from below to brown and crisp the food. Microwaves heat the pan through the active layer at the bottom of the pan. The active layer is designed to stop absorbing microwaves at 410°F (210°C). The Crisper Pan reaches that temperature in approximately 3 minutes. Use the pan as quickly as possible after it is heated for optimum temperature.

**IMPORTANT:** Pan Heat must be used before the other Crisp or Sizzle features are used.

- Use the handle to grasp and remove the Crisper Pan from the oven.
- Do not use plastic utensils on the pan, as it becomes very hot quickly and could melt the utensils.
- Do not use metal utensils, as they can scratch the pan.
- Do not use the pan in any other microwave oven or in a thermal oven.
- Always use the turntable as a support for the pan. Do not place the pan on the cooking rack.
- For best results, coat Crisper Pan lightly with cooking oil to make removing food and cleaning easier.

#### **To Use Pan Heat:**

1. Touch PAN HEAT once.  
Pan will preheat for 3 minutes.

#### **CRISP OR SIZZLE FEATURES**

Use the following chart as a guide when using Crisp or Sizzle.

FEATURE PAD	TOUCH	for AMOUNT
PIZZA (Frozen)	1 time	7 in. (17.78 cm) pizza
	2 times	9 in. (22.86 cm) pizza
	3 times	12 in. (30.48 cm) pizza
CHICKEN (Boneless Breast)	1 time	1 piece
	2 times	2 pieces
	3 times	3 pieces
	4 times	4 pieces
HAMBURGER	1 time	1 hamburger
	2 times	2 hamburgers
	3 times	3 hamburgers
	4 times	4 hamburgers

#### **To Use Crisp or Sizzle:**

1. Use Pan Heat.
2. Touch Crisp or Sizzle feature pad repeatedly, until the desired amount of food to be cooked appears in the display. Refer to chart above.
3. Touch START to begin cooking.  
If not touched within 5 seconds of completing step 2, cooking will begin automatically.

Cooking times/doneness may be adjusted by touching COOK POWER before touching START.

# MICROWAVE OVEN CARE

## General Cleaning

**IMPORTANT:** Before cleaning, make sure all controls are off and the oven is cool. Always follow label instructions on cleaning products.

Soap, water and a soft cloth or sponge are suggested first unless otherwise noted.

### GREASE FILTERS

Do not operate the microwave oven without the grease filters in place.

Soak grease filters in hot water and mild detergent. Scrub and swish to remove embedded dirt. Rinse well and shake dry.

- Do not use ammonia or oven cleaner.
- Do not place in dishwasher.

### OVEN CAVITY

Do not use soap-filled scouring pads, abrasive cleaners, steel-wool pads, gritty wash cloths or some paper towels. Damage may occur.

On stainless steel models, rub in direction of grain to avoid damaging.

The area where the oven door and frame touch when closed should be kept clean.

#### Average soil

- Mild, non-abrasive soaps and detergents:  
Rinse with clean water and dry with soft, lint-free cloth.

#### Heavy soil

- Mild, non-abrasive soaps and detergents:  
Heat 1 cup (250 mL) of water for 2 to 5 minutes in oven. Steam will soften soil. Rinse with clean water and dry with soft, lint-free cloth.

#### Odors

- Lemon juice or vinegar:  
Heat 1 cup (250 mL) of water with 1 tablespoon (15 mL) of either lemon juice or vinegar for 2 to 5 minutes in oven.

### OVEN DOOR EXTERIOR

- Glass cleaner and paper towels or non-abrasive plastic scrubbing pad:  
Apply glass cleaner to soft cloth or sponge, not directly on panel.

### TURNTABLE

Do not operate the microwave without the turntable in place.

- Mild cleanser and scouring pad
- Dishwasher

### CRISPER PAN

- Mild cleanser and scouring sponge
- Dishwasher

## Replacing Filters

The grease filters should be removed and cleaned at least once a month. The charcoal filters cannot be washed and should be replaced every six to twelve months. Do not operate the microwave oven without the filters in place. See "Assistance or Service" to reorder filters. See "General Cleaning" for cleaning instructions.

## ⚠ WARNING



### Electrical Shock Hazard

**Disconnect power before removing filters.**

**Replace all panels before operating.**

**Failure to do so can result in death or electrical shock.**

#### To Remove:

1. Unplug microwave oven or disconnect power.
2. Remove the grease filters by pushing up and sliding to the side. Pull tab down until the filter drops out.

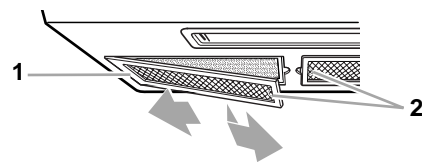

1. Push up
2. Tabs

3. Remove charcoal filters by pushing the back of each filter away from you until the front of the filter slides off the front lower lip. Swing the front of the filter down and slide out.

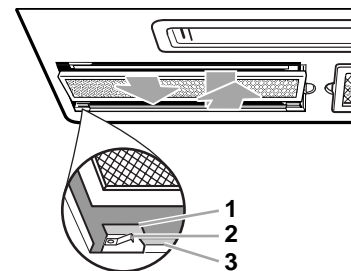

1. Upper lip
2. Spring
3. Lower lip



### To Replace:

1. Replace charcoal filters by positioning the filter at the back of the opening and resting it on the springs. While pushing the filter into the springs, position the front of filter between the front upper and lower lips.
2. Replace grease filters by inserting one end into the frame. Swing other side up and slide into position.
3. Plug in microwave oven or reconnect power.

---

## Replacing Cooktop Light

The cooktop light is a candelabra base 30-watt bulb. See "Assistance or Service" section to reorder.

### To Replace:

1. Unplug microwave oven or disconnect power.
2. Remove the bulb cover mounting screws.

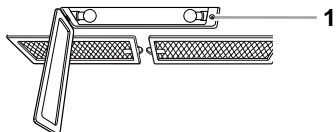

1. Mounting screw

3. Replace light. Close bulb cover. Replace mounting screws.
4. Plug in microwave oven or reconnect power.

---

## Replacing Microwave Oven Light

The microwave oven light is a 10W low-voltage halogen capsule bulb. It will automatically come on when the door is opened and when the microwave oven is operating. See "Assistance or Service" section for replacement ordering instructions.

### To Replace:

1. Unplug microwave or disconnect power.
2. Remove the two outer vent grille mounting screws located above the cover.

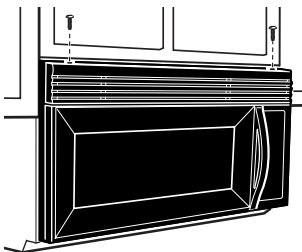

3. Tip the grille forward, then lift out to remove.

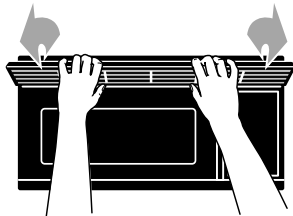

4. Lift up the bulb cover.

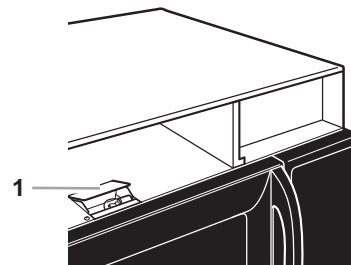

1. Bulb cover

5. Remove the burned-out bulb by squeezing the wire clip together, pulling to the right and lifting.

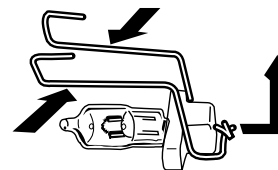

6. Replace bulb, using tissue to handle bulb, or wearing cotton gloves. **Do not touch bulb with bare fingers.**
7. Close bulb cover.
8. Slide the top of the vent grille into place. Push the bottom until it snaps into place. Replace the mounting screws.

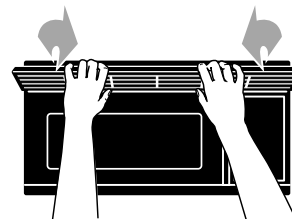

9. Plug in microwave oven or reconnect power.

---

# TROUBLESHOOTING

---

Try the solutions suggested here first in order to avoid the cost of an unnecessary service call.

---

## Nothing will operate

---

- **Has a household fuse been blown or has the circuit breaker been tripped?**  
Replace the fuse or reset the circuit.
  - **Is the appliance wired properly?**  
See Installation Instructions provided with your microwave oven.
- 

## Oven will not operate

---

- **Is the door completely closed?**  
Firmly close door.
  - **Is the electronic oven control set correctly?**  
See "Microwave Oven Control" section.
  - **Is the Child Lock set?**  
See "Child Lock" section.
  - **Is the magnetron working properly?**  
Heat 1 cup (250 mL) of cold water for 2 minutes at 100% cooking power. If water does not heat, call for service. See "Assistance or Service" section.
- 

## Oven makes humming noise

---

- This is normal and occurs when the transformer in the magnetron cycles on.
- 

## Oven door looks wavy

---

- This is normal and will not affect performance.
- 

## Turntable will not operate

---

- **Is the turntable properly in place?**  
Make sure turntable is correct-side up and is sitting securely on the turntable support.
  - **Is the turntable support operating properly?**  
Remove turntable. Remove and replace turntable support. Replace turntable. Put in 1 cup (250 mL) of water, then restart oven. If still not working, call for service. See "Assistance or Service" section. Do not operate the oven without turntable and turntable support working properly.
- 

---

## Turntable rotates both directions

---

- This is normal and depends on motor rotation at beginning of cycle.
- 

## Display shows messages

---

- **Is the display showing an "Oven Status" screen, with a letter/number code and instruction to inform KitchenAid?**  
The oven has detected an internal problem. It has run a self-checking program and displayed the error. Call for service. See "Assistance or Service" section.
- 

## Display shows time countdown, but oven is not operating

---

- **Is the Timer in use?**  
See "Timer" section.
  - **Is the Learning Mode or Demo Learning Mode in use?**  
See "Learning Mode" or "Demo Learning Mode" section.
- 

## Tones are not sounding

---

- **Are tones turned off?**  
See "Tones" section.
- 

## Steam is coming from the vent grille

---

- Some steam is normal.
- 

## Fan running slower than usual

---

- **Has the oven been stored in a cold area?**  
The fan will run slower until the oven warms up to normal room temperature.
- 

## Cooking times seem too long

---

- **Is the cooking power set properly?**  
See "Cooking Power" section.
  - **Are large amounts of food being heated?**  
Larger amounts of food need longer cooking times.
  - **Is the incoming voltage less than specified in "Microwave Oven Safety"?**  
Have a qualified electrician check the electrical system in the home.
- 

## Radio or TV Interference

---

- **Is the microwave oven plugged into the same outlet?**  
Try a different outlet.
  - **Is the radio or TV receiver near the microwave oven?**  
Move the receiver away from the microwave oven, or adjust the radio or TV antenna.
  - **Are the microwave oven door and sealing surfaces clean?**  
Make sure these areas are clean.
-

---

# ASSISTANCE OR SERVICE

Before calling for assistance or service, please check "Troubleshooting." It may save you the cost of a service call. If you still need help, follow the instructions below.

When calling, please know the purchase date and the complete model and serial number of your appliance. This information will help us to better respond to your request.

## If you need replacement parts

If you need to order replacement parts, we recommend that you only use factory specified parts. These factory specified parts will fit right and work right because they are made with the same precision used to build every new KITCHENAID® appliance.

To locate factory specified parts in your area, call our Customer Interaction Center telephone number or your nearest KitchenAid designated service center.

---

## In the U.S.A.

Call the KitchenAid Customer Interaction Center toll free:  
**1-800-422-1230.**

### Our consultants provide assistance with:

- Features and specifications on our full line of appliances.
- Installation information.
- Accessory and repair parts sales.
- Specialized customer assistance (Spanish speaking, hearing impaired, limited vision, etc.).
- Referrals to local dealers, repair parts distributors, and service companies. KitchenAid designated service technicians are trained to fulfill the product warranty and provide after-warranty service, anywhere in the United States.

To locate the KitchenAid designated service company in your area, you can also look in your telephone directory Yellow Pages.

## For further assistance

If you need further assistance, you can write to KitchenAid with any questions or concerns at:

KitchenAid Brand Home Appliances  
Customer Interaction Center  
553 Benson Road  
Benton Harbor, MI 49022-2692

Please include a daytime phone number in your correspondence.

---

Replacement Part	Part No.
Glass Turntable	4393751
Turntable Support	4393752
Turntable Rollers	4393753
Turntable Hub	4393754
Crisper Pan	4393536
Grease Filters	4393691
Charcoal Filter	4393690
Cooking Rack	4393826
Cooktop and Microwave Halogen Capsule Bulb	8169418

---

---

# KITCHENAID<sup>®</sup> MICROWAVE HOOD COMBINATION WARRANTY

---

## ONE-YEAR FULL WARRANTY

For one year from the date of purchase, when this appliance is operated and maintained according to instructions attached to or furnished with the product, KitchenAid will pay for factory specified parts and repair labor costs to correct defects in materials or workmanship. Service must be provided by a KitchenAid designated service company.

---

## SECOND THROUGH FIFTH YEAR LIMITED WARRANTY

In the second through fifth years from the date of purchase, KitchenAid will pay for factory specified parts for the microwave magnetron tube, any electric oven element and the solid state touch control system to correct defects in materials or workmanship.

---

## SECOND THROUGH TENTH YEAR LIMITED WARRANTY

In the second through tenth years from date of purchase, KitchenAid will pay for factory specified parts for the stainless steel oven cavity/inner door if the part rusts through due to defects in materials or workmanship.

---

### KitchenAid will not pay for:

1. Service calls to correct the installation of your appliance, to instruct you how to use your appliance, to replace house fuses or correct house wiring, or to replace owner-accessible light bulbs.
  2. Repairs when your appliance is used in other than normal, single-family household use.
  3. Pickup and delivery. Your appliance is designed to be repaired in the home.
  4. Damage resulting from accident, alteration, misuse, abuse, fire, flood, improper installation, acts of God or use of products not approved by KitchenAid.
  5. Repairs to parts or systems resulting from unauthorized modifications made to the appliance.
  6. Replacement parts or repair labor costs for units operated outside the United States.
  7. Any labor costs during the limited warranty period.
- 

## KITCHENAID SHALL NOT BE LIABLE FOR INCIDENTAL OR CONSEQUENTIAL DAMAGES.

Some states do not allow the exclusion or limitation of incidental or consequential damages, so this exclusion or limitation may not apply to you. This warranty gives you specific legal rights, and you may also have other rights which vary from state to state.

**Outside the 50 United States, this warranty does not apply. Contact your authorized KitchenAid dealer to determine if another warranty applies.**

If you need service, first see the "Troubleshooting" section of this book. After checking "Troubleshooting," additional help can be found by checking the "Assistance or Service" section or by calling the KitchenAid Customer Interaction Center, **1-800-422-1230** (toll-free), from anywhere in the U.S.A.

5/00

---

**Keep this book and your sales slip together for future reference. You must provide proof of purchase or installation date for in-warranty service.**

Write down the following information about your appliance to better help you obtain assistance or service if you ever need it. You will need to know your complete model number and serial number. You can find this information on the model and serial number label/plate, located on your appliance as shown in the "Parts and Features" section.

**Dealer name** \_\_\_\_\_

**Address** \_\_\_\_\_

**Phone number** \_\_\_\_\_

**Model number** \_\_\_\_\_

**Serial number** \_\_\_\_\_

**Purchase date** \_\_\_\_\_